

WHEN DISASSEMBLING ALUMINUM EXTRUSION, TIGHTEN ALL SETSCREWS AND LOCKS TO PREVENT LOSS DURING SHIPPING

visionary™ DESIGNS

Using Your Setup Instructions

The Visionary Designs Setup Instructions are created specifically for your configuration. They are laid out sequentially, including an exploded view of the entire display, and then a logical series of detailed steps to assemble the main structure and components. We encourage you to study the instructions **before** attempting to assemble your exhibit.

Each page reminds you to tighten the setscrews after disassembling your exhibit to prevent loss of the locks and setscrews (see below in RED). This is **VERY IMPORTANT**.

Cleaning and Packing Your Display

- 1) Use care when cleaning aluminum extrusion or acrylic inserts. Use only non-abrasive cleaners.
- 2) When cleaning laminate inserts or countertops, use mild cleansers and a soft material such as cotton.
- 3) Keep all display components away from extreme heat and long exposure to sunlight to avoid warping and fading.
- 4) Retain all packing material. It will make re-packing much easier and will reduce the likelihood of shipping damage.



The Tool

Most Visionary Designs exhibits can be assembled with the supplied Hex Key Tool. Occasionally, a flat head screwdriver may be required.



Typical Connection



Typical Connection (cont'd)

Most horizontal extrusion connections have a patented expandable lock. This lock inserts into the groove of an opposing extrusion. Tightening the lock with the Hex Key Tool expands the lock and creates a strong positive connection.

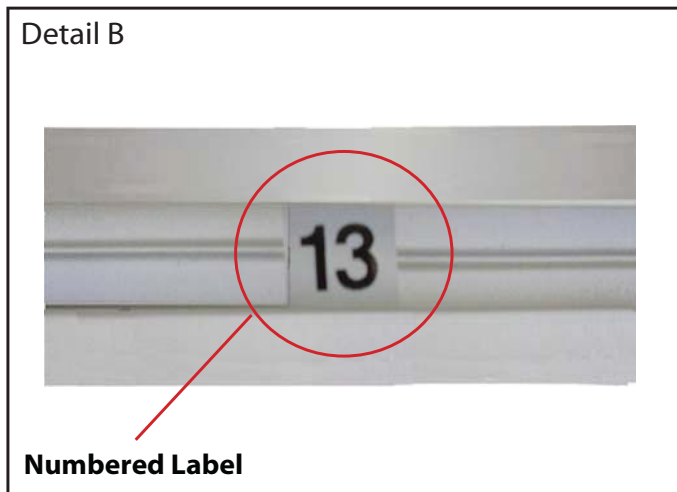

Detail B

Numbered Label

Each extrusion contains a numbered label which corresponds with setup instructions. The label is located within a groove of the extrusion (when possible). With Visionary Designs the labels contain Black numbers unless otherwise specified.



Detail C

Horizontal Inline Connection (remove only one setscrew)

Remove only (1) setscrew when disassembling. Replace setscrew in extrusion after assembling it. Before packing, replace setscrew in extrusion to avoid losing it.

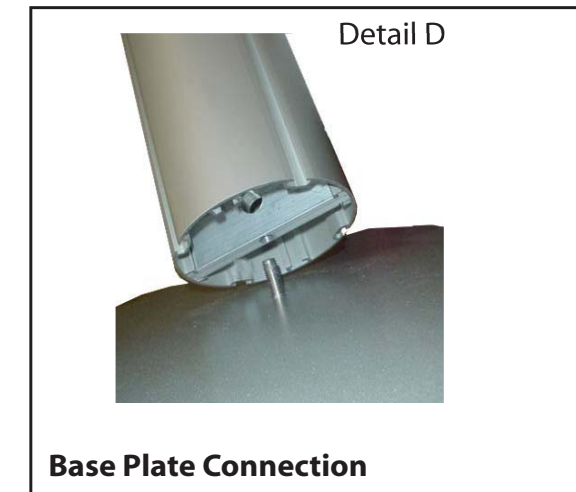

Detail D

Base Plate Connection

Attach base plate to round or square vertical extrusion using the bolt provided. Be careful not to strip the threads.

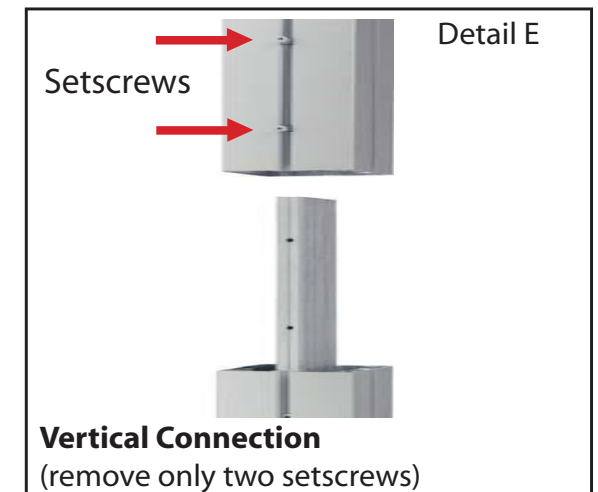

Detail E

Vertical Connection
(remove only two setscrews)

When vertical extrusions are packed in portable cases rather than crates or tubs, they must be broken down into smaller sections which then require assembly.

Remove only (2) setscrews when disassembling. Replace setscrews in extrusion after assembling it. Before packing, replace setscrews in extrusion to avoid losing them.

WHEN DISASSEMBLING ALUMINUM EXTRUSION, TIGHTEN ALL SETSCREWS AND LOCKS TO PREVENT LOSS DURING SHIPPING

866.652.2100

Part Number	Qty	Description
1	2	Base Plate
2	1	48.115" Lower Curved Extrusion
3	1	48.115" Upper Curved Extrusion
4	1	47"h Lower Vertical Extrusion
5	1	47"h Upper Vertical Extrusion
6a/6b	1/1	52.476" Horizontal Curved Extrusion
7a/7b	1/1	52.476" Horizontal Curved Extrusion

Steps:

- 1) Attach vertical extrusions to base plates [2 to 1 and 4 to 1].
- 2) Connect vertical pieces together [2 to 3 and 4/4a to 5/5a].
- 3) Connect curved extrusions together [6a to 6b and 7a to 7b].
- 4) Attach horizontal assemblies [6a/6b and 7a/7b] between

STAR indicates location of connection bar with knobs on BACKSIDE of unit.

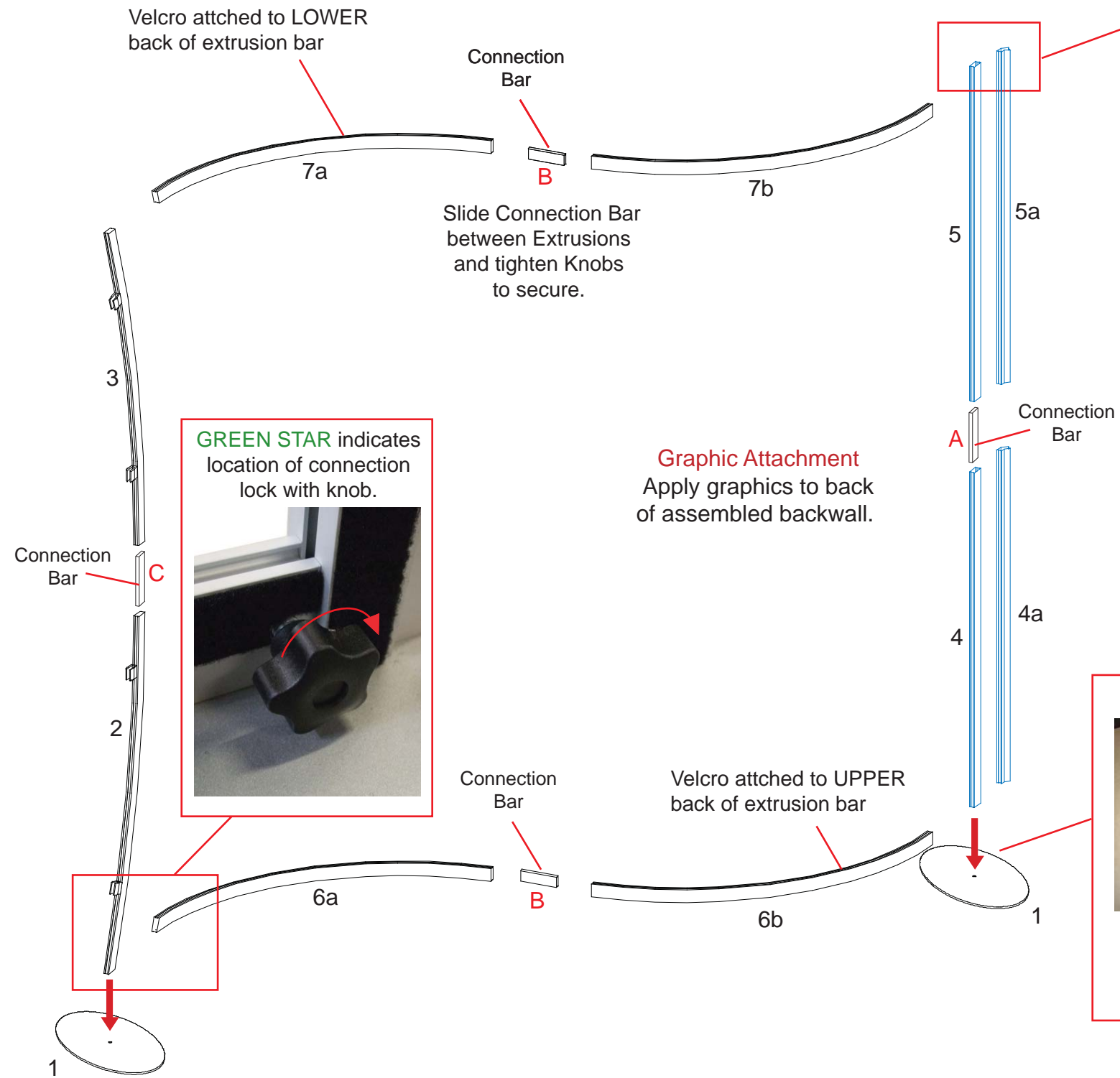
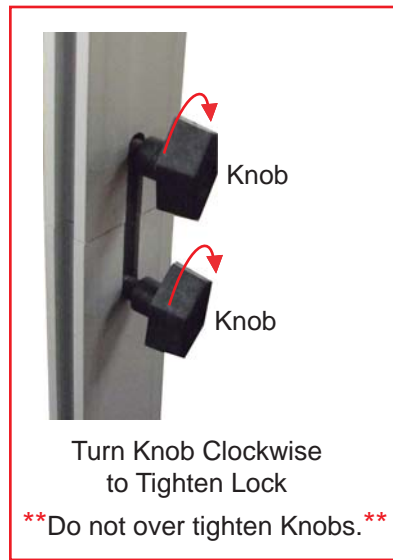
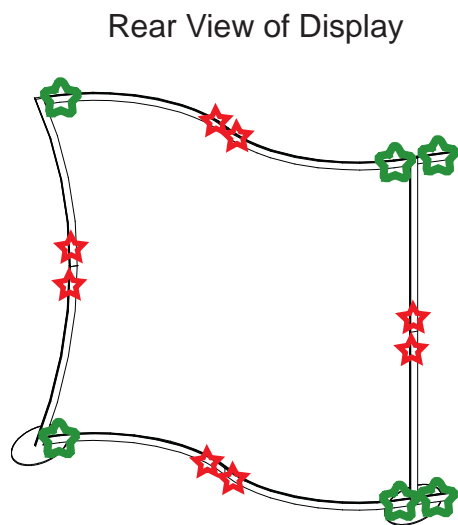

Graphic Attachment
Apply graphics to back of assembled backwall.

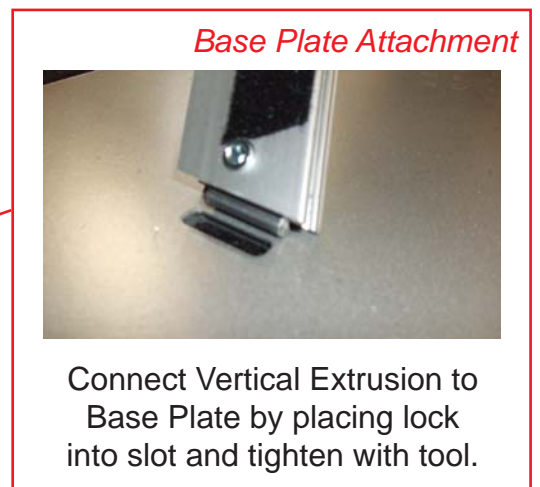
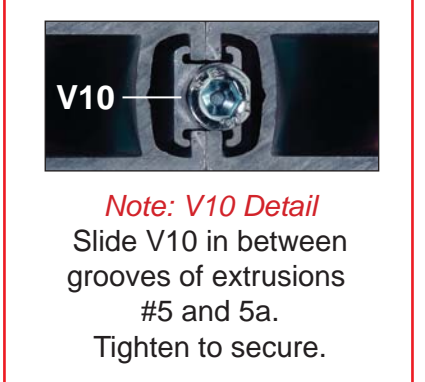
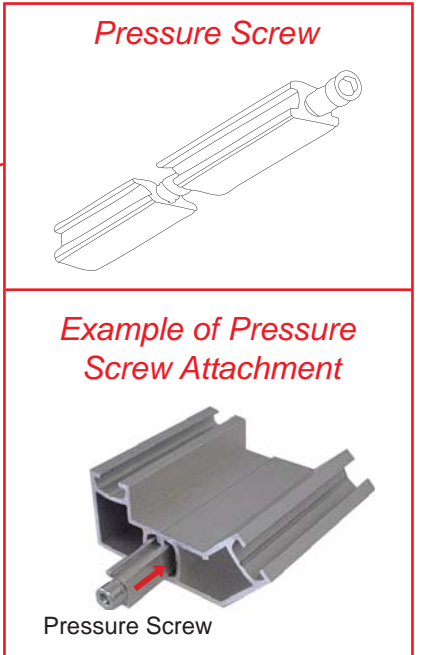

WHEN DISASSEMBLING ALUMINUM EXTRUSION, TIGHTEN ALL SETSCREWS AND LOCKS TO PREVENT LOSS DURING SHIPPING

Part Number	Qty	Description
1	2	Base Plate
8	1	47" h Lower Vertical Extrusion
8a	1	47" h Corner Extrusion
9	1	47" h Upper Vertical Extrusion
9a	1	47" h Corner Extrusion
10	1	48.115" Lower Curved Extrusion
11	1	48.115" Upper Curved Extrusion
12a/12b	1/1	52.476" Horizontal Curved Extrusion
13a/13b	1/1	52.476" Horizontal Curved Extrusion
14	2	25" w Horizontal Extrusion

Steps:

- 1) Attach vertical extrusions to base plates [8 to 1 and 10 to 1].
- 2) Connect vertical pieces together [8/8a to 9/9a and 10 to 11].
- 3) Connect curved extrusions together [12a to 12b and 13a to 13b].
- 4) Attach horizontal assemblies [12a/12b and 13a/13b] between vertical assemblies as shown.

RED STAR indicates location of connection bar with knobs on **BACKSIDE** of unit.

Rear View of Display

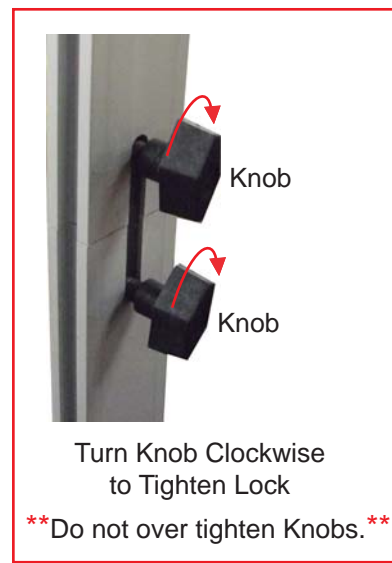
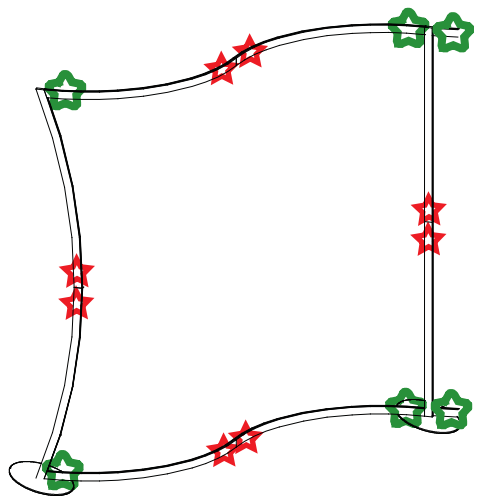

Note: Extrusions 8/8a and 9/9 must stay assembled when shipping.

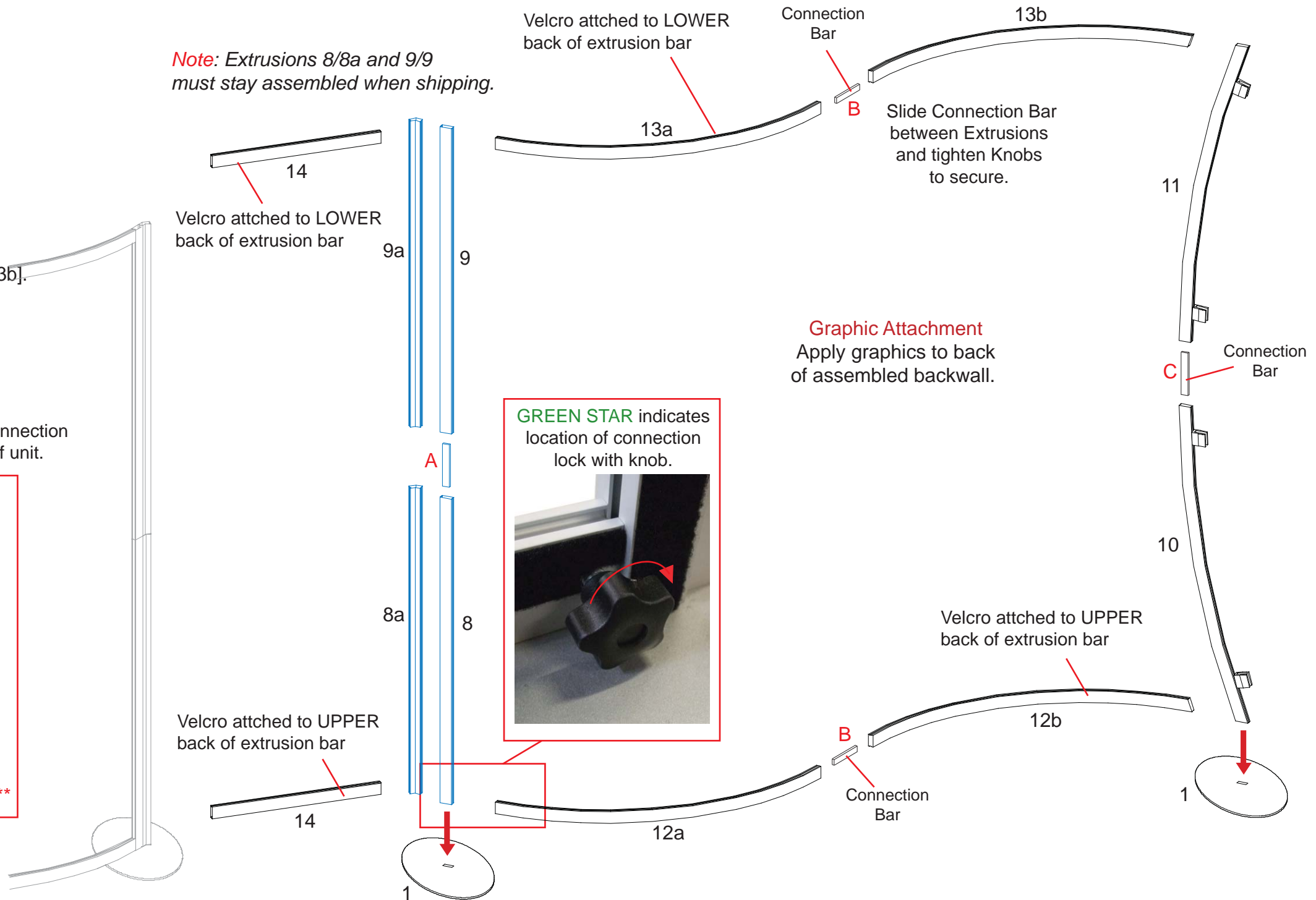

WHEN DISASSEMBLING ALUMINUM EXTRUSION, TIGHTEN ALL SETSCREWS AND LOCKS TO PREVENT LOSS DURING SHIPPING

866.652.2100

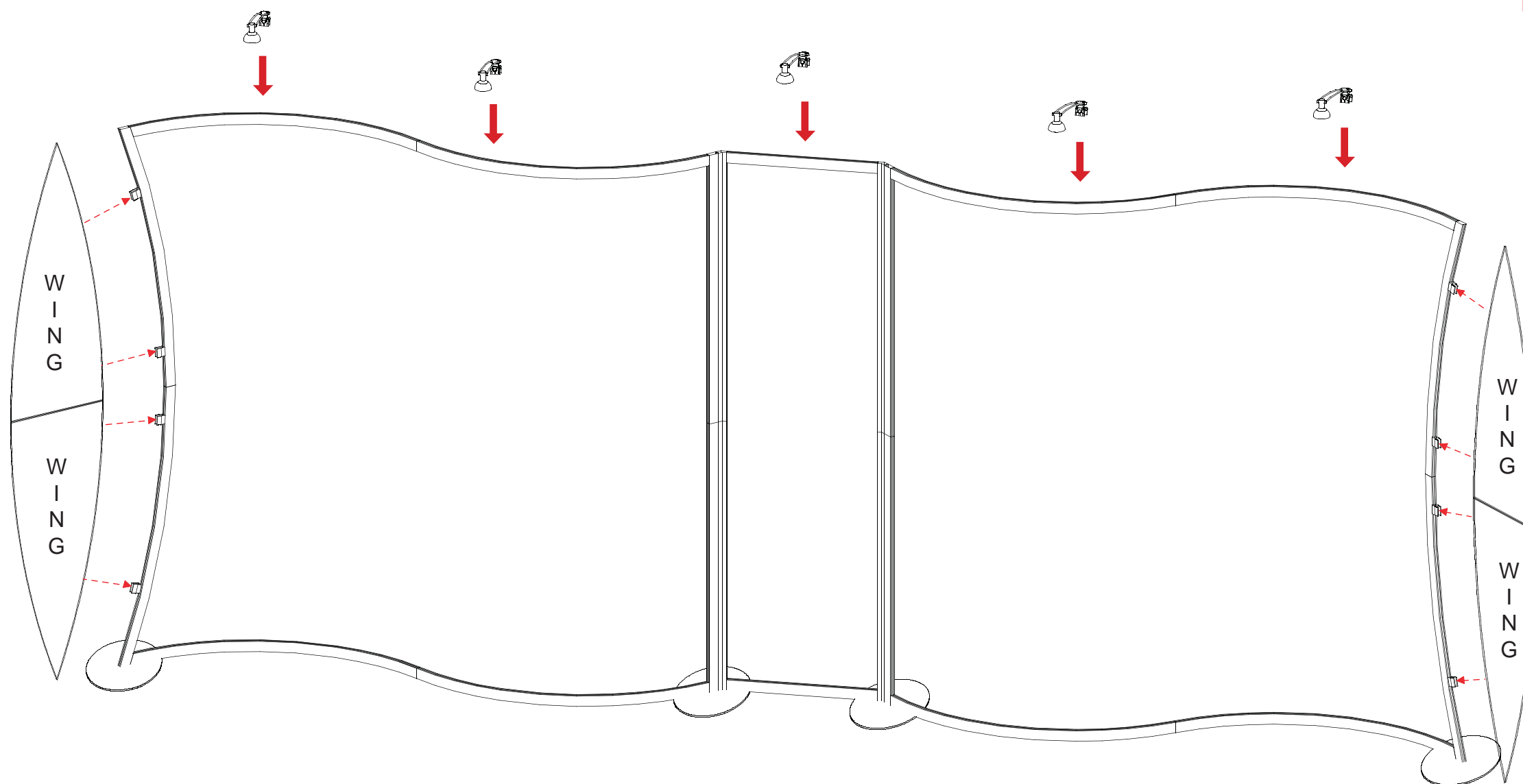
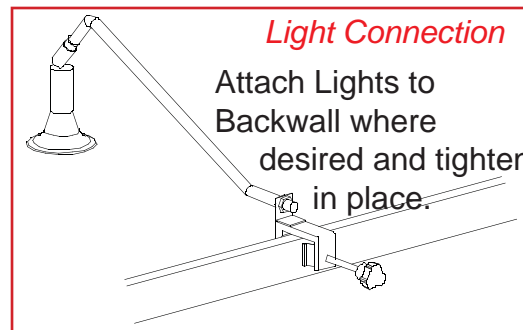

Wing Attachment

Slide A10 Clamp into groove of square extrusion.



When desired location is found, tighten set screw to secure.



Tighten black plastic set screw to secure Wing in place.



***Note:** A10 Clamps should remain attached to vertical extrusions

WHEN DISASSEMBLING ALUMINUM EXTRUSION, TIGHTEN ALL SETSCREWS AND LOCKS TO PREVENT LOSS DURING SHIPPING

Backwall Components

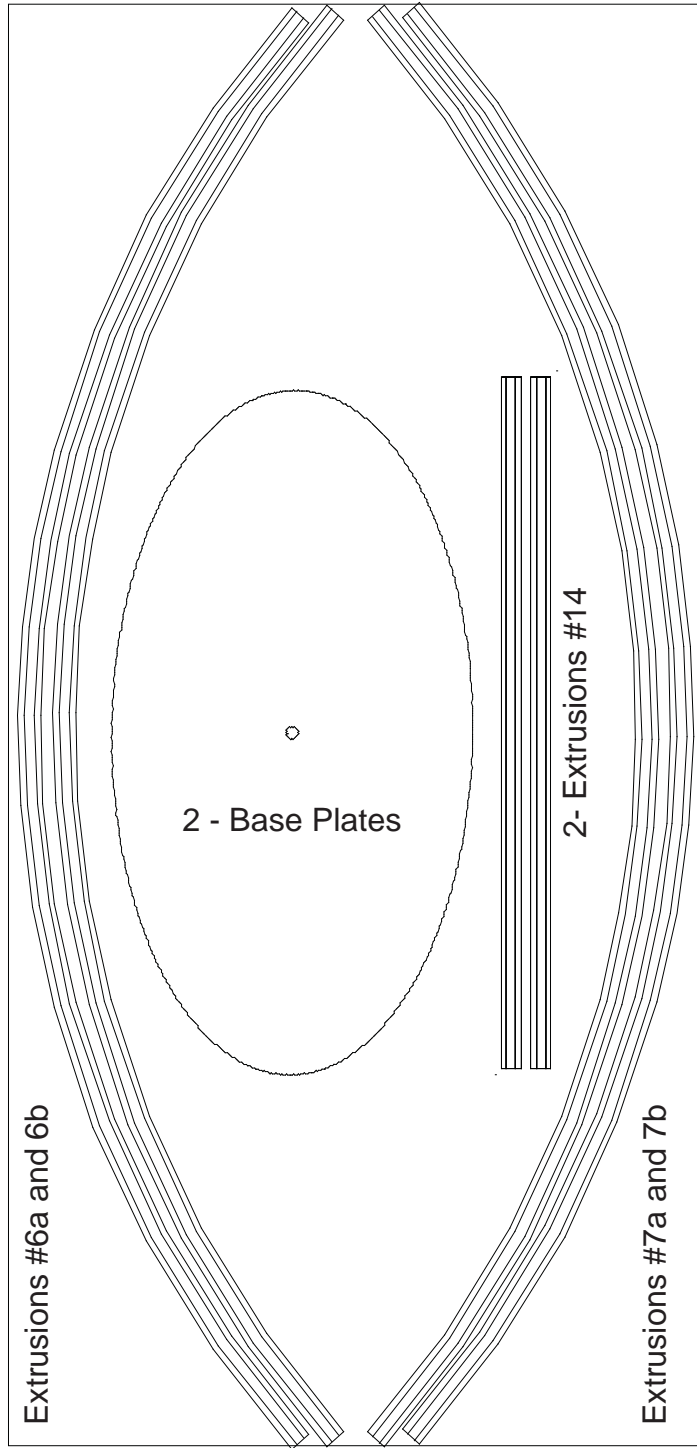

Level 1

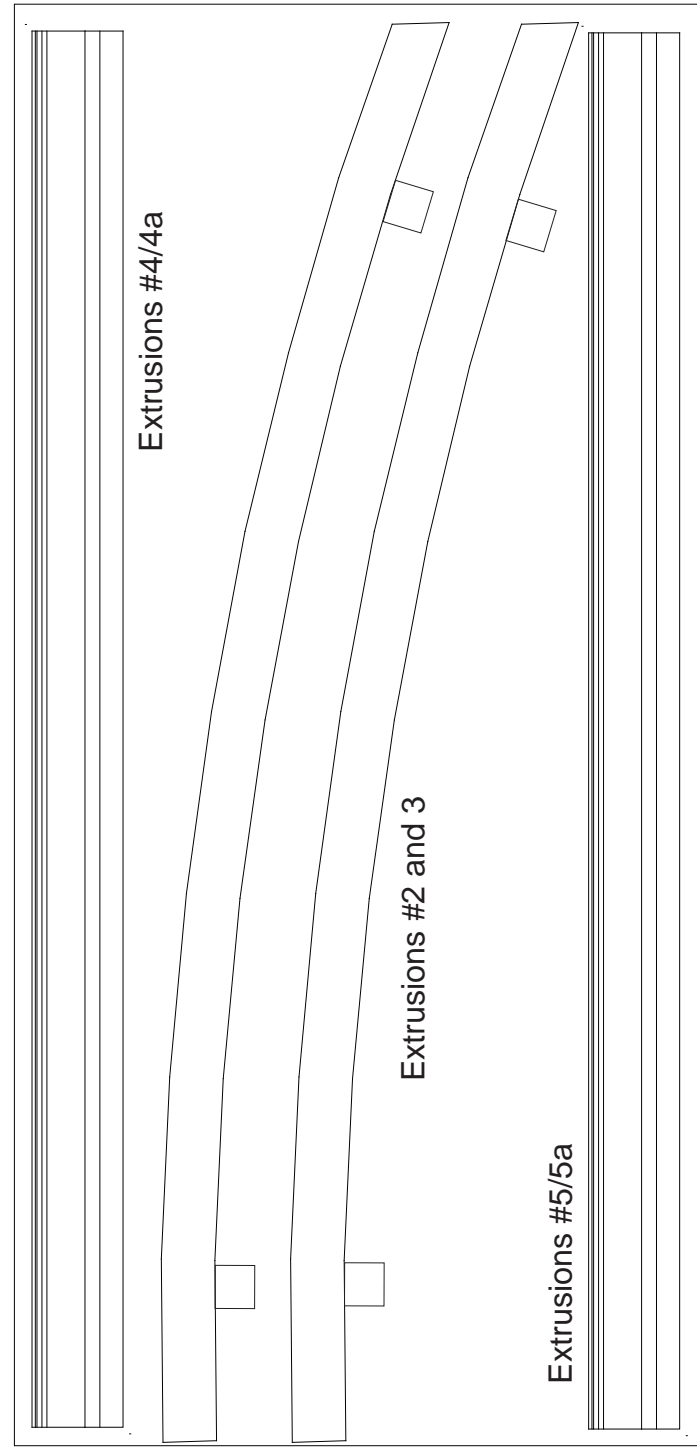

Level 2

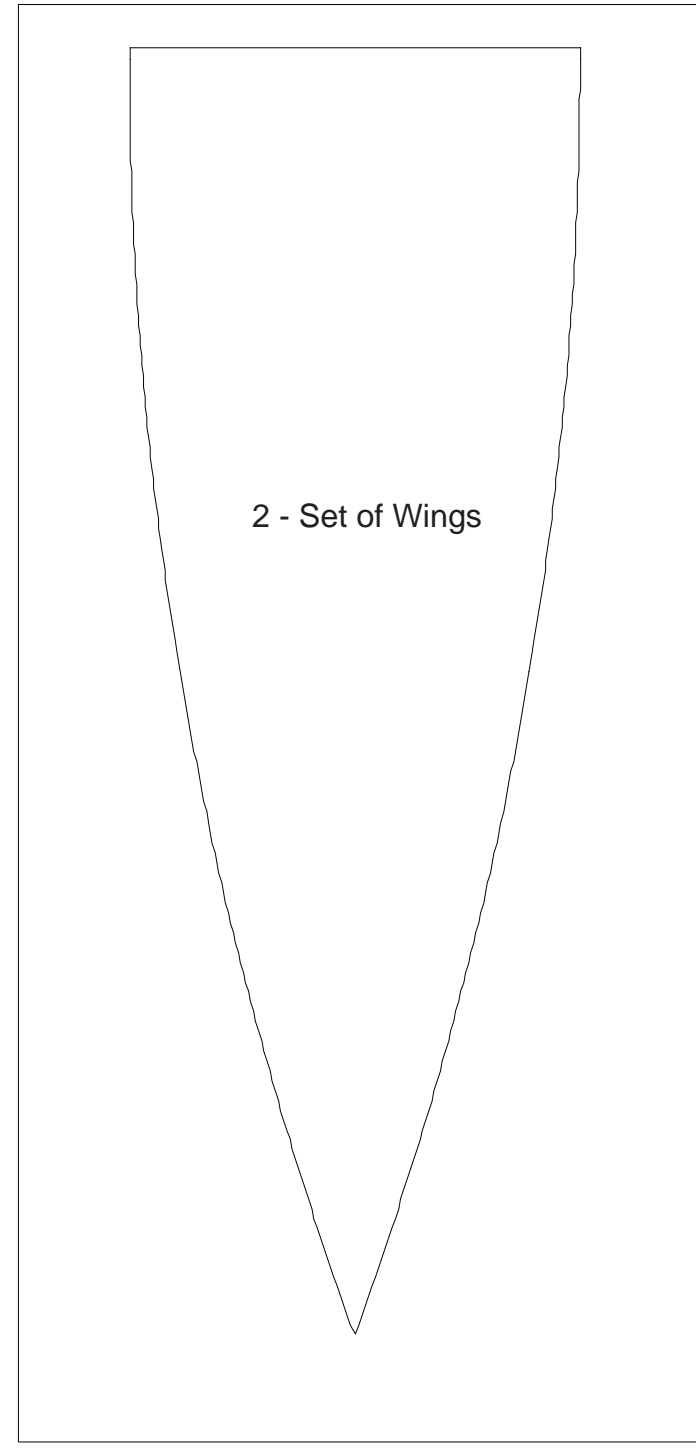

Level 3

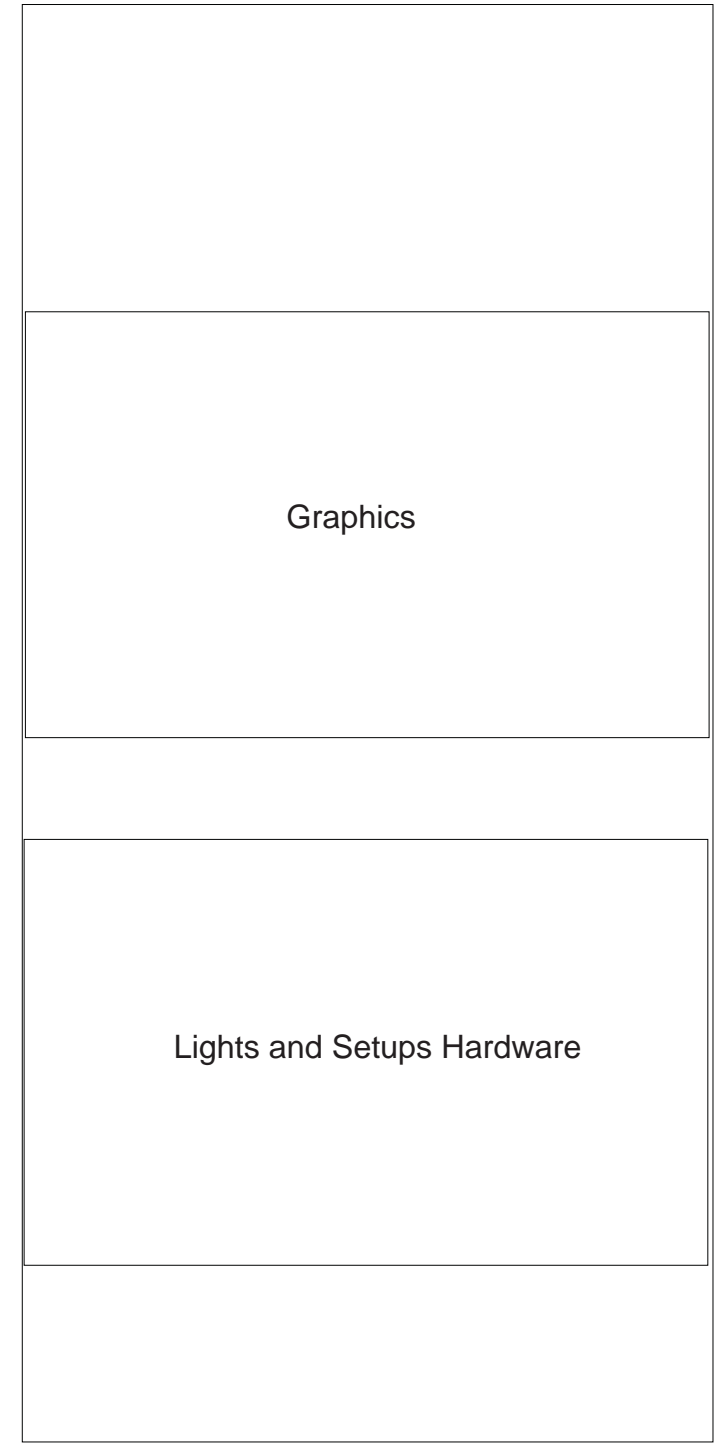

Slip Sheet

WHEN DISASSEMBLING ALUMINUM EXTRUSION, TIGHTEN ALL SETSCREWS AND LOCKS TO PREVENT LOSS DURING SHIPPING

Backwall Components cont'd

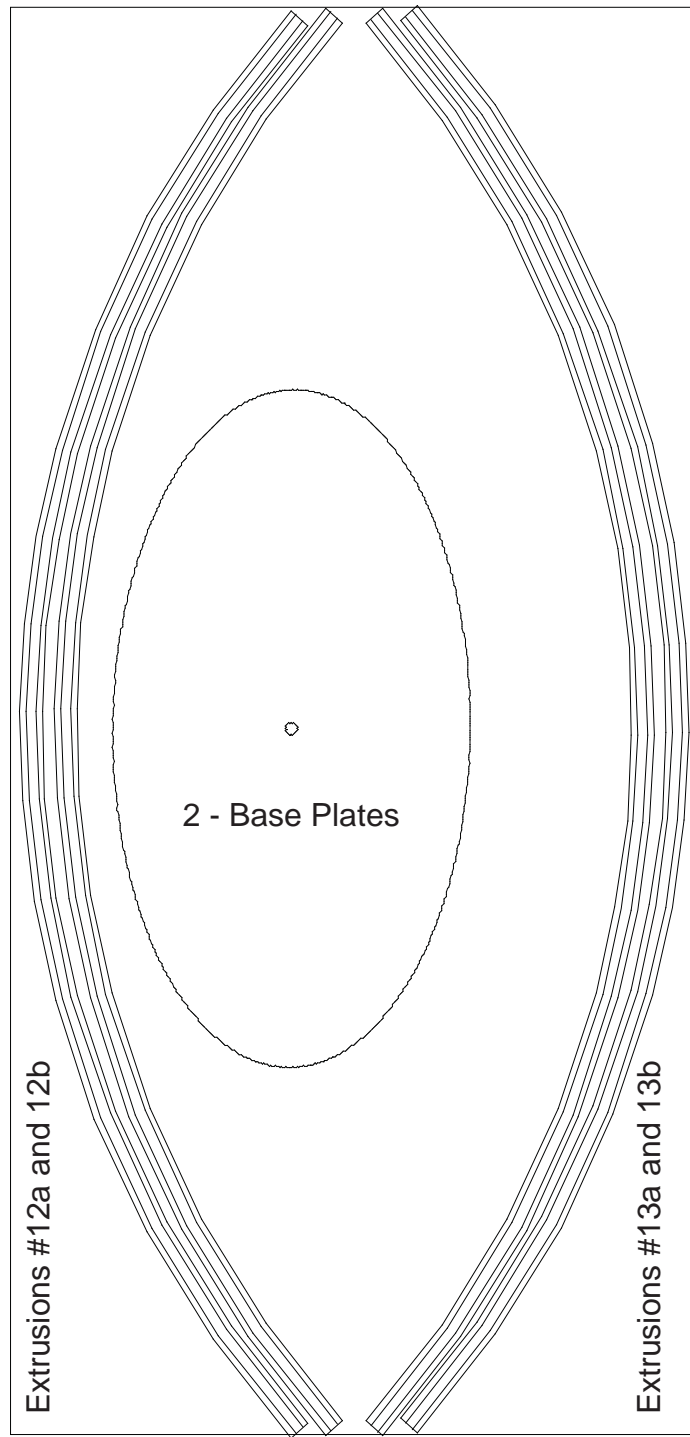

Level 1

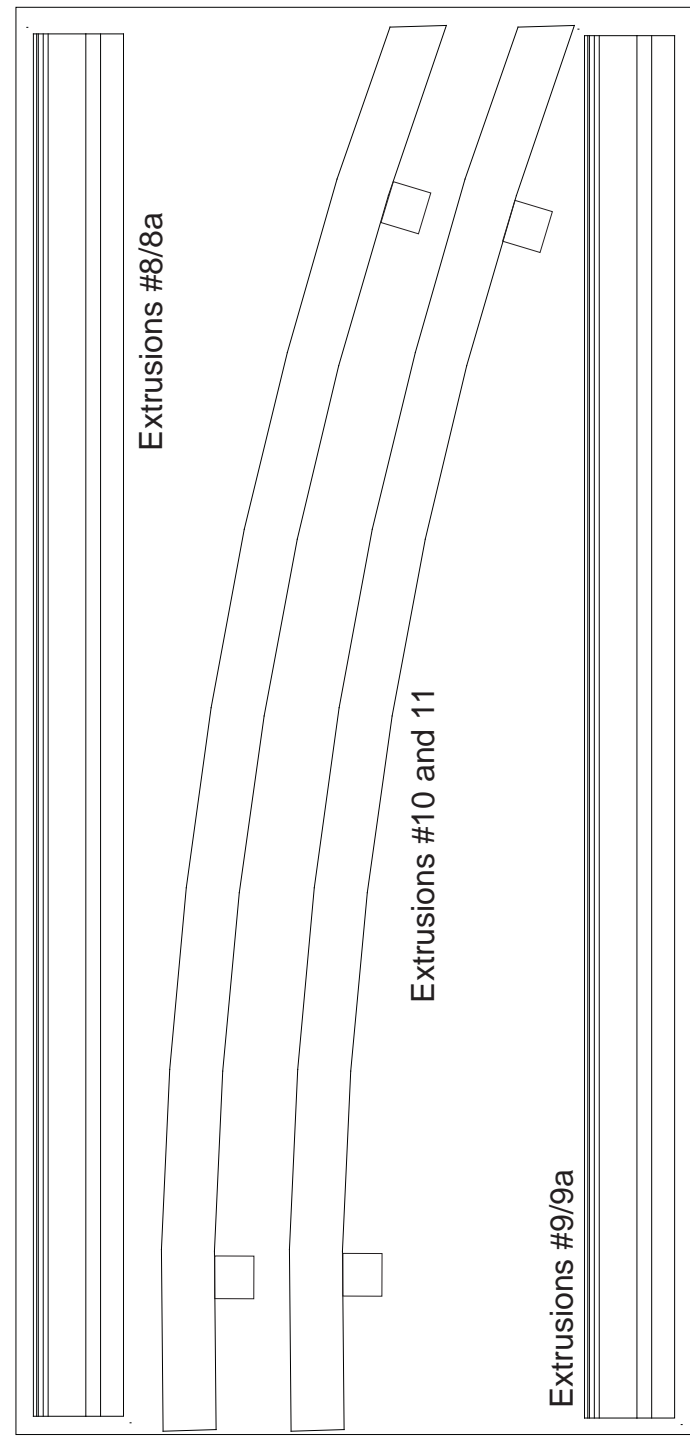

Level 2

WHEN DISASSEMBLING ALUMINUM EXTRUSION, TIGHTEN ALL SETSCREWS AND LOCKS TO PREVENT LOSS DURING SHIPPING